

# The NIST Research Reactor and Cold Neutron Source

Dr. Robert E. Williams  
Nuclear Engineer  
NIST Center for Neutron Research

June 23, 2005

## Outline

- Nuclear Engineering 101
- Description of the NBSR
- Production of Cold Neutrons
- Evolution of the Liquid Hydrogen CNS
- The Role of MCNP in CNS Development
- Liquid Deuterium Source Next?

## Nuclear Fission of $^{235}\text{U}$

- Because neutrons are emitted in fission, a self-sustaining chain reaction is possible.
- A reactor is *critical* if exactly one neutron from fission induces another fission.
- 200 MeV/fission is deposited in the core ( $3.1 \times 10^{10}$  fis/sec/watt).
- Fission products are neutron rich; there is radioactive decay heating long after shutdown.
- Slow neutrons more likely to cause fission.
  - Thermal reactors

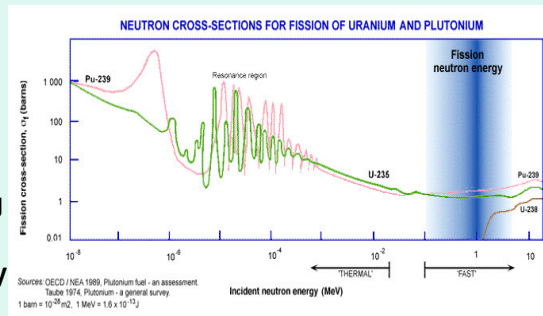
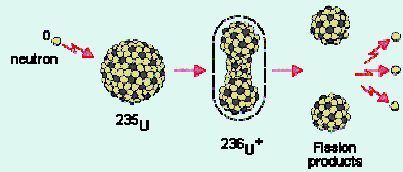

## Thermal Reactor Components

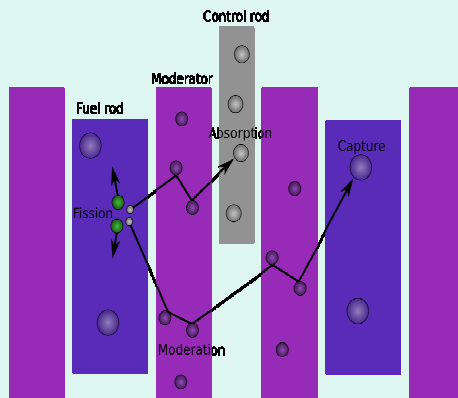

- **Fissile** fuel material, such as  $^{235}\text{U}$ , only 0.7% abundant, or  $^{239}\text{Pu}$ .
- **Moderator** to slow neutrons ( $\text{D}_2\text{O}$ ,  $\text{H}_2\text{O}$ , Graphite)
- Control Elements (Cd, B)
- Reflector, Shielding, Coolant, Neutron source and detectors
- Early Reactors:
  - Oklo, Gabon -1.7 billion B. C. E. (U ore +  $\text{H}_2\text{O}$ )
  - Univ. of Chicago – 1942 (Natural U + graphite)

## Reactor Kinetics and Control

The neutron **Multiplication Factor**,  $k$ , is

$$\frac{\text{Number of fissions in one generation}}{\text{Number of fissions in the previous generation}}$$

$k = 1.000$  for a critical reactor at steady power. **Reactivity**, approximately  $k-1$ , measures the departure from critical.

The neutron lifetime in most reactors is about 100  $\mu\text{sec}$ . One generation?

Let  $k = 1.001$ , for example. If the fission rate increased by 1.001 every  $10^{-4}$  sec, the power would increase a factor of  $(1.001)^{10,000} = 22,000$  in one second,  $5 \times 10^8$  in 2 seconds, etc. Oops!

Fortunately, about 0.7% of the neutrons are delayed; they are emitted in the beta decay of fission products, spanning thousands of "generations".

Slow moving control rods and negative power coefficients keep the reactivity well below 0.007, so the power increase is manageable.

## NIST Research Reactor History

- Designed in the 1960's, and included a beam port for a cold neutron source.
- First Critical, December 7, 1967.
- 10 MW until 1985, 20 MW since.
- D<sub>2</sub>O Cold Neutron Source installed, 1987.
- First neutrons in the guide hall in 1990.
- LH<sub>2</sub> Source installed September 1995
- Advanced LH<sub>2</sub> CNS, Unit 2, installed 2002.

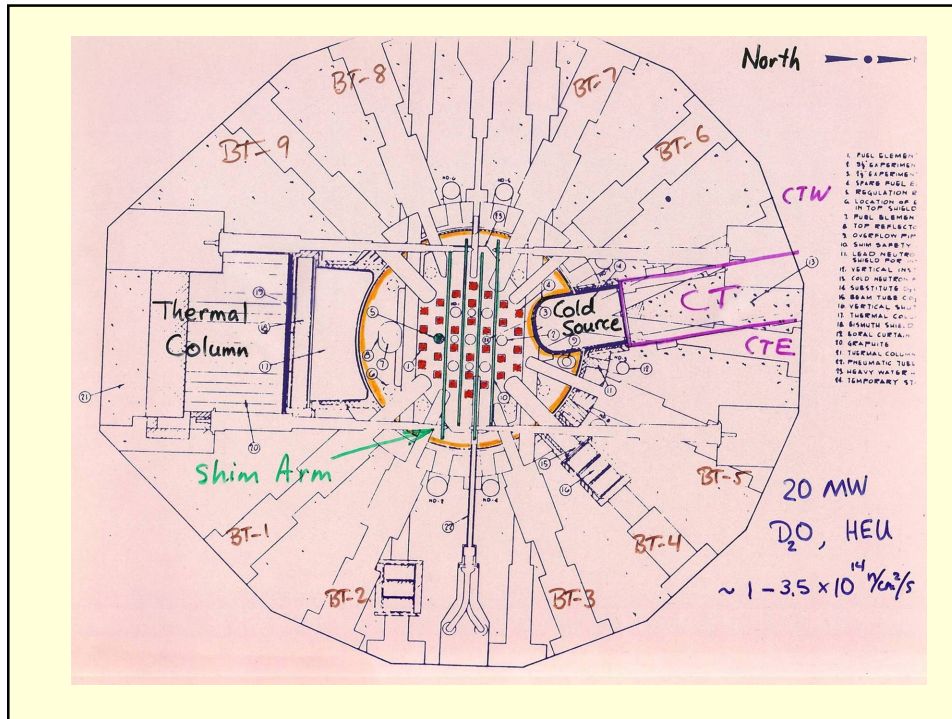

## Reactor Core Characteristics

- High Enrichment U Fuel: 93%  $^{235}\text{U}_3\text{O}_8 + \text{Al}$
- $\text{D}_2\text{O}$  Coolant, Moderator, Reflector
- 30 fuel elements
  - Fuel cycle 38 days
  - Load 4 fresh elements, reposition the others
- Peak Flux:  $3.5 \times 10^{14} \text{ n/cm}^2/\text{sec}$
- 9 radial thermal neutron beams
  - mid-plane (un-fueled region)
  - $1.5 \times 10^{14} \text{ n/cm}^2/\text{s}$
- 5 “rabbits” and 10 vertical thimbles for sample irradiations

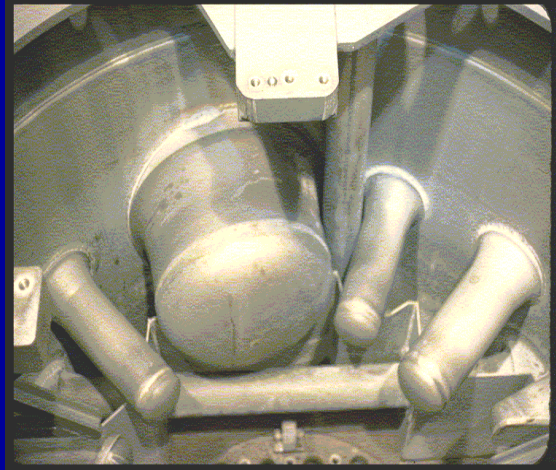

Interior of the NBSR vessel, showing BT-6, CT, BT-5 and BT-4 thimbles. The Cryogenic Thimble is 55 cm ID.

### Cut-away View of the NBSR Core

- Looking inside Al reactor vessel
- 18-cm gap (5) between the upper and lower fuel (18)
- Semaphore-type Cd shim arms (2)
- D<sub>2</sub>O flow inside the fuel elements
- CNS (15) visible in cutout CT thimble

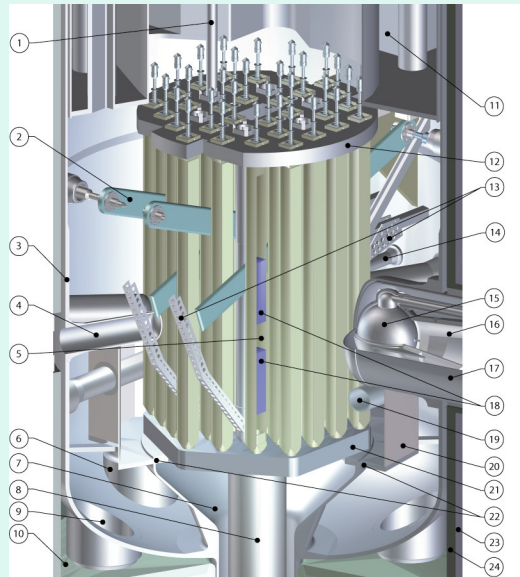

## Production of Cold Neutrons

- The neutrons born in fission have an average kinetic energy of about 2 *Mega*-electron volts, 2 MeV.
- They are slowed to thermal energies (20 – 400 *milli*-eV) by scattering from the molecules of the heavy water (D<sub>2</sub>O) moderator in the reactor. The D<sub>2</sub>O is about 108 °F, or 315 Kelvin.
- In thermal equilibrium, the neutron energy spectrum is determined solely by the temperature of the moderator (a Maxwell-Boltzmann distribution), analogous to the motion of atoms in an ideal gas.

To reach lower energies, therefore, we introduce a cold moderator, such as liquid hydrogen at 20 K.

## Effect of an Ideal Cold Moderator on the Neutron Flux Energy Spectrum

- The Maxwell-Boltzmann energy spectrum is
- $\Phi_{th}(E) = [\Phi_0 / T^{3/2}] E \exp(-E/kT)$
- In the limit of  $E \rightarrow 0$ , the maximum theoretical gain of a cold source at 20 K with respect to a thermal spectrum at  $T_0 = 315$  K is:
- $Gain(E \rightarrow 0) = [T_0/T]^{3/2} = 62.$ 
  - Unit 1 had a maximum gain of about 45.

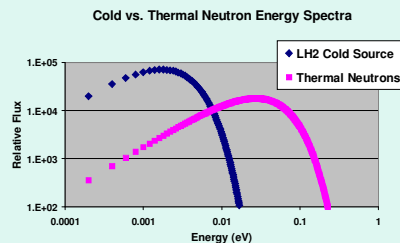

Moderator Temperature (K)	Most Probable Energy (meV)	Wavelength (Angstroms)
315	30	1.6
20	2	6.4

## D<sub>2</sub>O Ice Source – “Unit 0”

- Cryostat made of Mg
- 16 liters of ice at 30-35 K
- A Lead/bismuth shield (water cooled) required to reduce nuclear heating
- Optimum source contained 8% H<sub>2</sub>O (ice)
- Operated from 1987 to 1994
- Operational difficulties, but gain of 3x in cold neutrons
  - Unpredictable stored energy releases from recombination

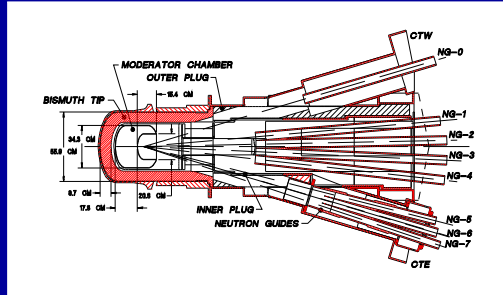

*A cold neutron has an energy of less than 5 meV, or a wavelength greater than 4 Å.*

## The liquid hydrogen cold source is passively safe, simple, and reliable

- A thermosiphon is the simplest way to supply the source with LH<sub>2</sub>.
  - Cold helium gas cools the condenser below 20 K.
  - Hydrogen liquefies and flows by gravity to the moderator chamber.
  - Vapor rises to the condenser and a naturally circulating system is established.
- Thermal hydraulic tests showed a thermosiphon could safely remove at least 2200 watts.
- The system is closed to minimize hydrogen gas handling.
- All system components are surrounded by He containments.

(Unit 2 CNS)

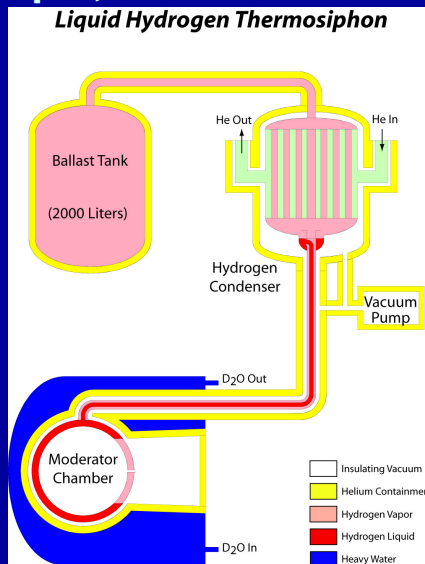



## The LH<sub>2</sub> CNS, Unit 1, installed in 1995, had a gain of 6 times the D<sub>2</sub>O source

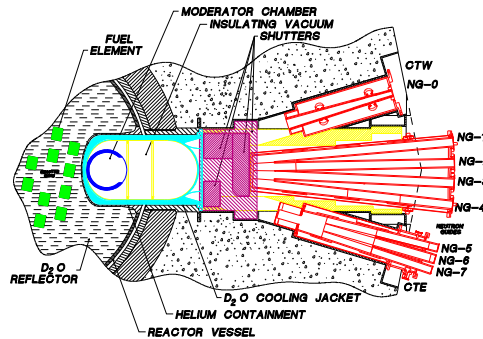

To fully illuminate the beam ports, the source had to have a very large area.

A 320-mm spherical annulus, 20 mm thick, with a 200-mm diameter exit hole was chosen:

- Low heat load (850 W)
- Ease of fabrication.  
Material: Al 6061-T6
- Composed of concentric Al spheres (5 liters of LH<sub>2</sub>)
- Hydrogen vapor filled the inner sphere, which was open at the bottom.

## The condenser is located outside the reactor, 2 meters above the source

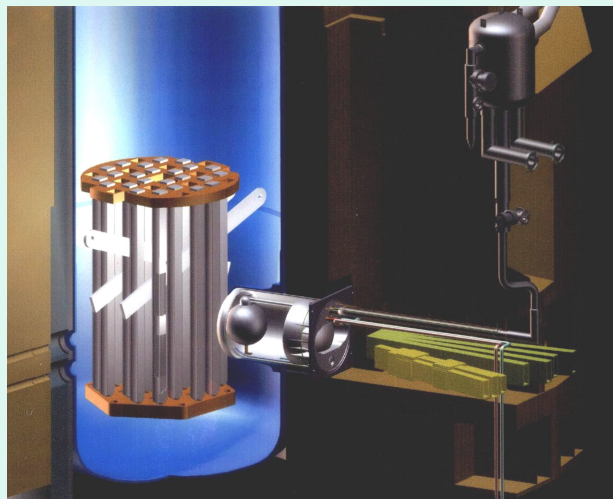



## The Advanced Liquid Hydrogen Cold Source – March, 2002

- Our MCNP model of the reactor core evolved since the initial design of the LH<sub>2</sub> cold source.
- Simulations showed that expanding the volume of D<sub>2</sub>O around the moderator chamber would better couple the source to the core.
- Several changes were incorporated in Unit 2:
  - Expanded the D<sub>2</sub>O cooling jacket to partially surround the moderator.
  - Eliminated the vapor-filled region in the interior.
  - Used a smaller chamber and a thicker annulus for LH<sub>2</sub>.
- The thermosiphon, ballast tank, refrigerator and I&C systems were unchanged.

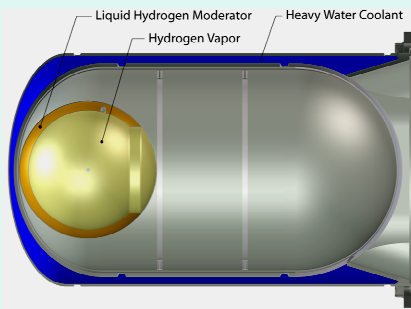

**Hydrogen Cryostat Unit 1**

Unit 1 had too much empty space next to the reactor core.

Vapor in the inner sphere scattered cold neutrons from the beam.

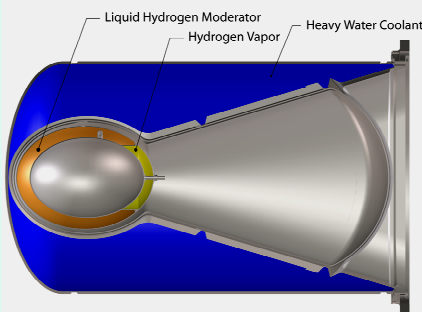

**Advanced Hydrogen Cryostat**

Much more D<sub>2</sub>O in Unit 2 results in a higher neutron flux in the CNS region and the adjacent fuel elements.

32 x 24 cm ellipsoid allows more D<sub>2</sub>O and a thicker LH<sub>2</sub> annulus.

Vacuum filled inner ellipsoid.

## The MCNP Model of the NBSR

- MCNP (Monte Carlo Neutron-Photon) is a transport code with generalized geometry:
  - Cold moderator cross section data
  - Criticality calculations for reactor normalization
- Initially used to model the cold source region for performance and heat load calculations.
- 30 fuel elements in a hexagonal array, with all 1020 fuel plates, cladding, coolant, etc.
  - 30 fuel materials with varying burn-up
  - Each step for the 7- and 8- cycle fuel elements
  - Shim arms, regulating rod, beam tubes, etc.
- MCNP was used extensively in the updated SAR for the reactor relicensing effort.

The MCNP model of the NBSR was created for CNS development.

The code has generalized geometry and scattering kernels for cold moderators, and powerful variance reduction techniques to tally low-probability events.

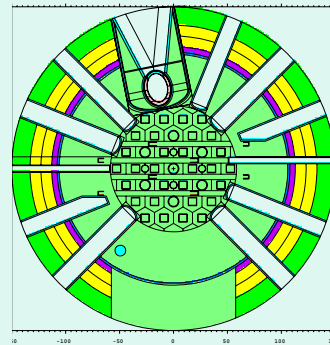
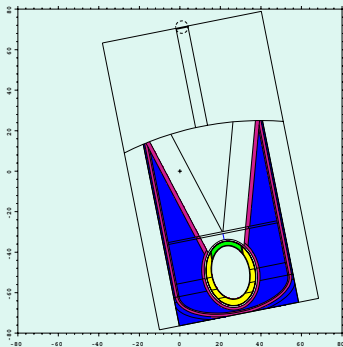

A surface source was generated from the whole-core criticality calculation for CNS performance calculations.

This source preserves the normalization.

The DXTRAN feature was used to force "pseudo" particles to a current tally plane at the neutron guide entrance.

## Calculated Nuclear Heat Load for Unit 2

(Watts)	LH <sub>2</sub> (320 g)	Al (2840 g)
Neutrons	98	2
Beta Particles	-	270
Gamma Rays	196	837
<b>Totals</b>	<b>294</b>	<b>1109</b>

One short coming of MCNP is that the code can only directly tally the contributions to the heat load from *prompt* radiation.

Gamma rays from fission products and radioisotopes are not included.

## Nuclear Heat Load Discrepancy between MCNP Calculations and Measurements

- The calculated heat load for Unit 2 was 1400 watts, using “modified” cross sections for <sup>235</sup>U and Al that include delayed gamma rays.
- This procedure had OVER estimated the heat in Unit 1 by 10-15%, so we expected 1200 watts.
- Indirect measurements indicate 1150-1200 W, based on the output of the return gas heater with and without the reactor heat load.
- Poses a problem for a possible deuterium CNS.

## Unit 3: A Liquid Deuterium Source for NBSR?

A 42 x 42 cm liquid deuterium source in the CT thimble.

Large volume: 45 liters

Deuterium inventory would be many times our H<sub>2</sub> inventory.

10 kg @ 300 kPa will have an expansion volume of nearly 20 m<sup>3</sup> (10 times our ballast tank)

Big investment in metal hydride storage units may be needed to contain tritium.

Calculated heat load of 2700 watts (1.3-mm thick Al wall) will tax our refrigerator.

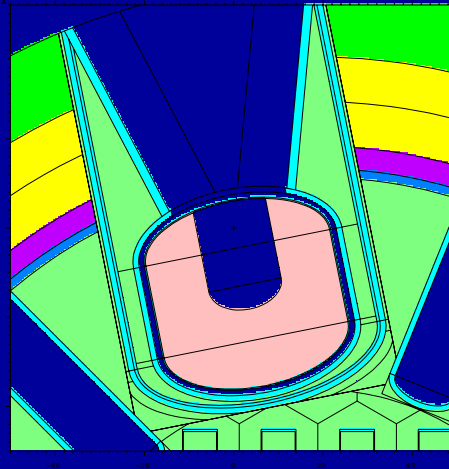

## Relative Brightness of a 45-liter LD<sub>2</sub> CNS vs. Unit 2, 0 – 20 meV

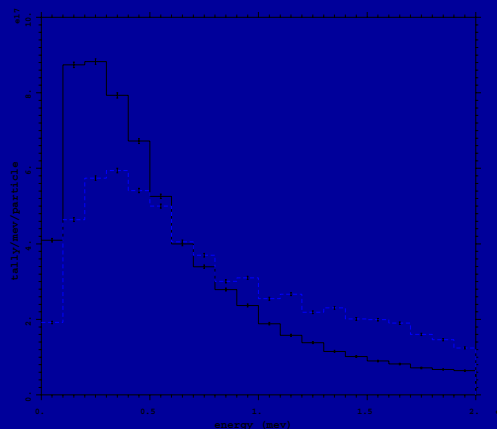

Blue -- Unit 2

Black – LD<sub>2</sub> source

- Spectrum shifts to lower energies
- Gain greater than 2 for the longest wavelengths
- Maxwell-Boltzmann temperature drops from 38 K to 28 K
- Small loss of intensity for 5 - 10 meV
- 50% loss at 15 meV (2.5 Angstroms)

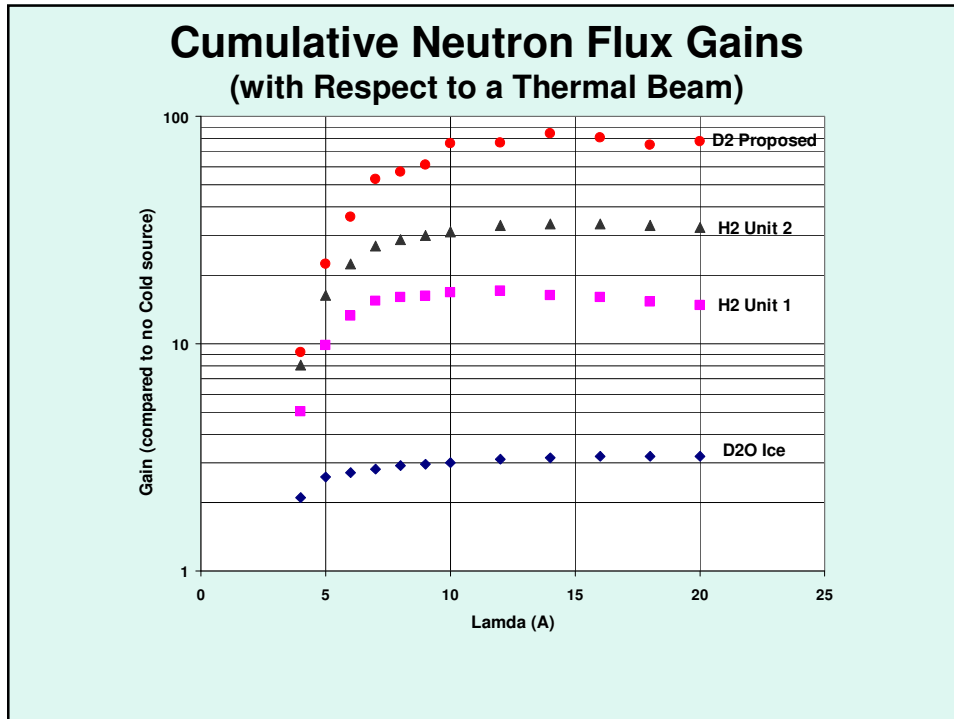

## Conclusion

- 2005 marks 20 years since the work began on the D<sub>2</sub>O cold source.
  - 10<sup>th</sup> anniversary of the first LH<sub>2</sub> source
- We continue to explore ways to better utilize the facility.
  - Cold source upgrade
  - Advances in optics, instrument development
- MCNP is a critically important tool in the effort.